

CO

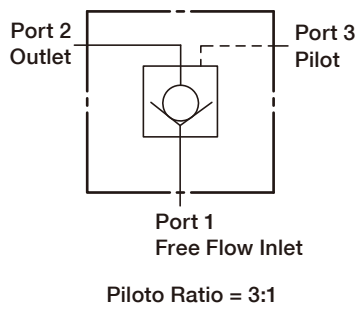

SYMBOLS



ORDER CODES

CO **2A** - **T11A** - **X** **C** **N**

1 2 3 4 5 6

1	▶ Model Name	CO	
2	▶ Valve Size	1A, 2A, 3A, 6A, 8A	
3	▶ Cavity	T163A, T11A, T2A, T17A, T19A	
4	▶ Control Manner	X	standard pilot
5	▶ Cracking Pressure	A	0.3 bar
		C	2.0 bar
		E	5.0 bar
6	▶ Material of Seal	N	buna-N
		V	viton

MODEL SPEC.

Model	Cavity	Capacity (l/min)	Max. Pressure (bar)	Installation Torque (Nm)	Operational Temperature	Weight (kg)
CO1A	T163A	40	350	30/40	-35 ~ 100°C (-31 ~ 212°F)	0.10
CO2A	T11A	80	350	40/50		0.13
CO3A	T2A	160	350	60/70		0.24
CO6A	T17A	320	350	200/215		0.53
CO8A	T19A	640	350	465/500		1.19

PERFORMANCE CURVES

► Typical Pressure Drop

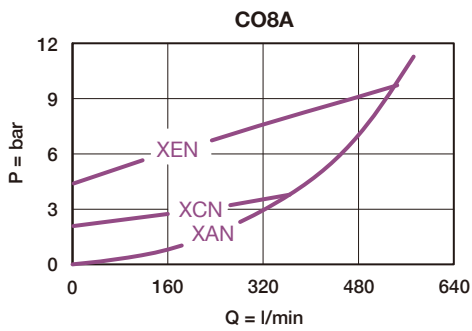
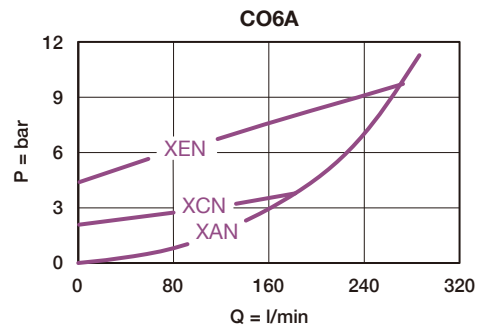
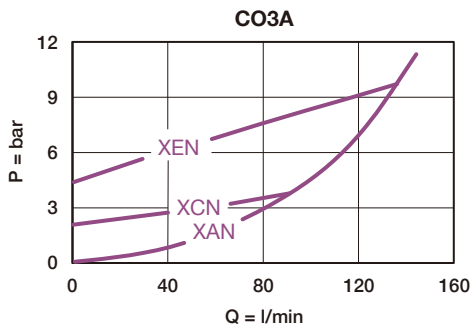
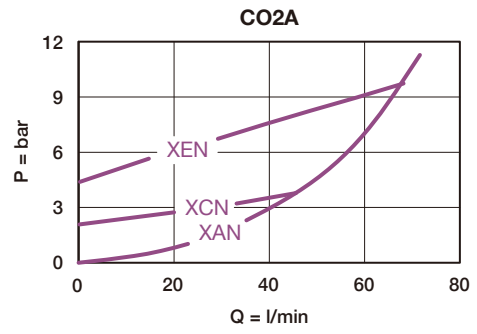
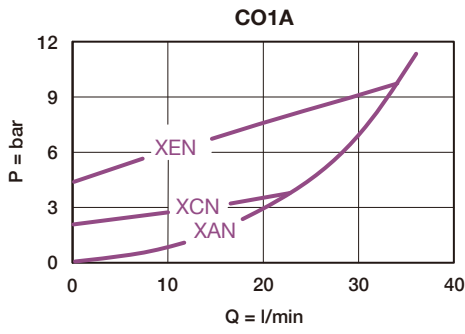

DIMENSION

(UNIT : mm)

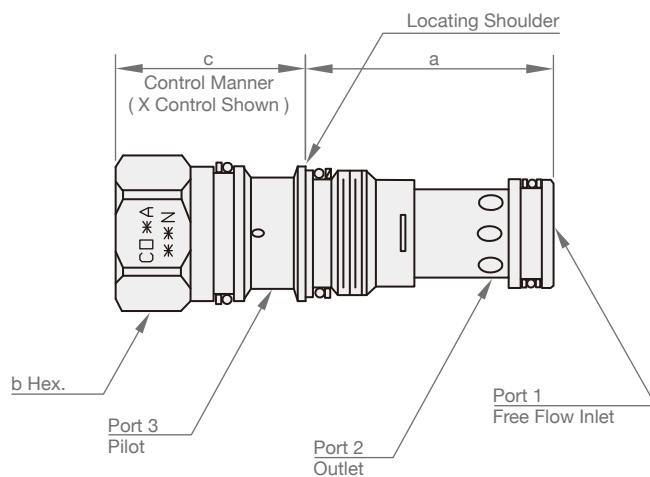

Model	a	b	c
			X
CO1A	31.0	19.1	32
CO2A	34.9	22.2	31
CO3A	34.9	28.6	35
CO6A	46.0	31.8	46
CO8A	63.5	41.3	59